



STELLAR® 32,000 LB. HOOKLIFT TECHNICAL SPECIFICATION GUIDE

32,000

Shuttle Hooklift Hoist



Our People. Our Products.

STELLAR® 32,000 LB. CAPACITY HOOKLIFT HOIST

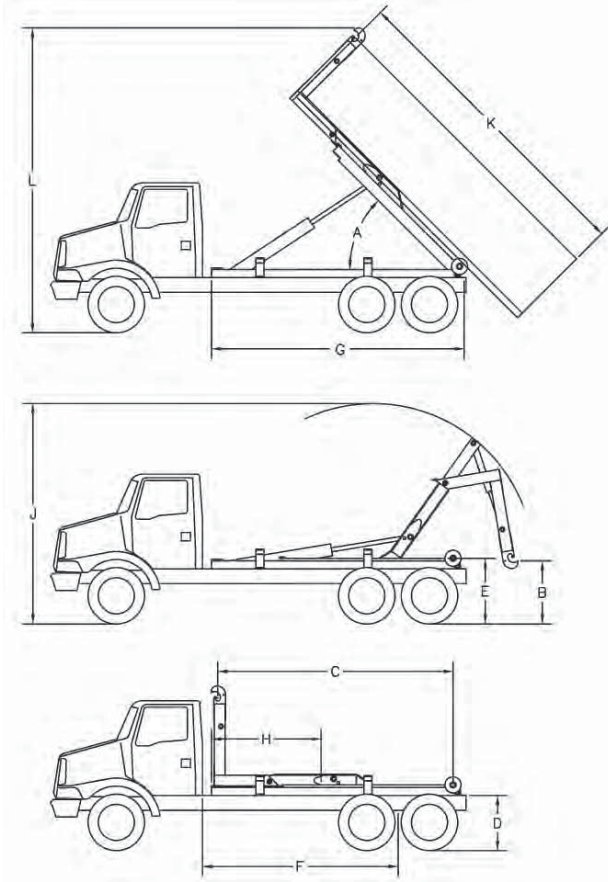

■ SPECIFICATION INFORMATION

- Will accommodate bodies from 12-feet up to 17.5-feet long and still retain the maximum rated dump angle on a 41-inch high frame truck. Longer bodies may be accommodated with reduced dumping capabilities.
- Transmission-mounted PTO and hydraulic pump required to power the hooklift.
- Standard in-cab manual controls which allow for precise metering of the manual stack-type hydraulic valve. Solenoid-activated hydraulic control valve with electric remote control pendant is optional.
- Twenty-Five (25) gallon frame-mounted oil tank.
- Operating pressure is 4,200 psi.
- Hydraulic flow required is 20-gallons per minute.
- Patented dump/load interface on double pivot models.
- Hydraulic locks to prevent cylinder collapse in case of hose failure.
- Hook latch to prevent body from becoming detached prematurely.
- Mechanical rear body tie-down latches.
- Resettable dump/tilt tabs.
- Hydraulic rotary valve to prevent front tilt movement when the dump frame is raised.
- Pre-lubricated greaseable bushings used at pivot points.
- Carbon steel and zinc plated or type 17-4 stainless steel pins used throughout.
- All weldments painted with two-part polyurethane enamel.

Item Description	108-14-32	138-18-32	174-20-32	190-24-32
Lifting / Dumping Cap.	32,000 lb. (14,515 kg)	32,000 lb. (14,515 kg)	40,000 lb. (18,144 kg)	40,000 lb. (18,144 kg)
Dump Angle	57°	50°	50°	51°
Effective Length	144" (3,658 mm)	176" (4,470 mm)	206" (5,232 mm)	223" (5,664 mm)
Cab to Trunnion	102"-108" (2,590-2,743 mm)	130"-144" (3,302-3,658 mm)	160"-174" (4,064-4,420 mm)	174"-190" (4,420-4,826 mm)
Shipping Weight	3,600 lb. (1,633 kg)	3,900 lb. (1,769 kg)	4,900 lb. (2,223 kg)	5,400 lb. (2,449 kg)
Rec. Body Lengths	12'-15' (3,658-4,572 mm)	15'-17.5' (4,572-5,334 mm)	17.5'-20' (5,334-6,096 mm)	19'-21.5' (5,791-6,553 mm)
Hook Height	61.75" (1,568 mm)	61.75" (1,568 mm)	61.75" (1,568 mm)	61.75" (1,568 mm)
Min. Truck GVWR	32,000 lb. (14,515 kg)	32,000 lb. (14,515 kg)	43,000 lb. (19,504 kg)	43,000 lb. (19,504 kg)

■ KEY FEATURES

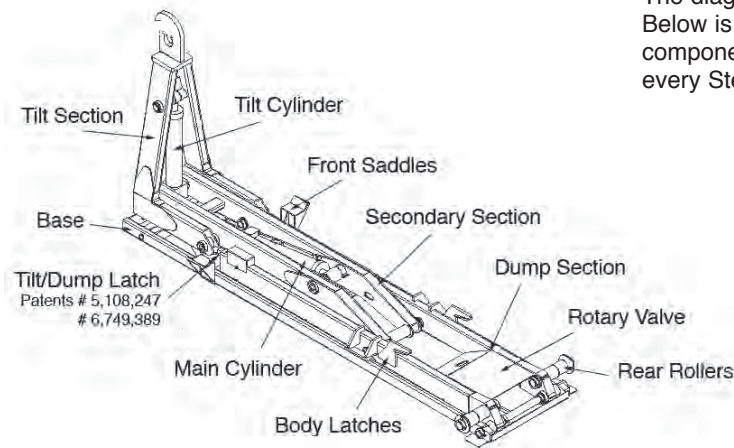

The diagram shows a typical Stellar Hooklift. Below is a detailed explanation of these components which are an integral part of every Stellar hydraulic hooklift.

- Base Section:** The base section of a Stellar Hooklift may also be called a sub-frame. All Stellar Hooklift hoists are tied together in one common framework. This base section not only adds strength to the hoist, but it places less stress concentration on the truck chassis than hook hoists without a common base. The base section also provides for a simple installation on most truck chassis.
- Body Latch:** The body latch is also referred to as the rear tie-down. Standard on Stellar Hooklift hoists are the rearward facing hooks that interface with a horizontal steel pocket or tab. As the body is pulled forward into the final storage position prior to transporting, the tabs will pull tight in the hook pockets. Hydraulic activated rear tie-downs are optional on larger Stellar Hooklift hoists.
- Dump Section:** This component of the Stellar Hooklift pivots at the rear of the hoist when interacting with the patented tabs on the tilt section. The rear body latches are attached to this component on most models. This allows the body to remain in the latches when dumping.
- Front Saddles:** Front saddles provide a place for the body to rest while the truck is in motion.
- Lift Cylinder:** The lift cylinder on a Stellar Hooklift not only lifts the body onto the truck, but it also provides the dumping movement. All Stellar Hooklift lift cylinders feature dual pilot-operated counterbalance valves which provide for optimum meter-ability and protection against sudden movement in the case of hose failure.
- Tilt/Dump Latch:** This unique patented feature is the basis of the Stellar Hooklift system. With a simple mechanical interference between the tilt section and the dump section, the pivot point is changed from the secondary section (loading/off-loading) to the rear of the truck (dumping). Resettable tabs protect the system from out-of-sequence operation.
- Rear Rollers:** With the unique Stellar Hooklift design, bodies are loaded and unloaded with a “lift and roll” movement. While unloading a body, the tilt section will lift the front of the body and roll it back. The tilt cylinder will continue rolling the body until the rear of the body contacts the ground.
- Rotary Valve:** The rotary valve will lock out all hydraulic fluid to the tilt cylinder when in the dumping mode. This prevents the accidental release of the body while dumping.
- Secondary Section:** The secondary section acts as the main pivoting member for loading /off-loading bodies. This component ties the tilt, dump and base sections together into one cohesive unit.
- Tilt Cylinder:** The tilt cylinder operates the tilt section of the Stellar Hooklift. This cylinder features a pilot-operated counterbalance valve on both extend and retract sides. The tilt section is a key component of the Stellar Hooklift. The tilt section provides the selection of dump or load/off-load. With Stellar’s unique twin post design, line-of-sight visibility of the hook is available from the truck cab.

■ Stellar® Hooklift Reference Chart*

Model	Hook Height	Lift Capacity (lbs)	Effective Length (in)	Body Lengths (ft)	Cab-To-Axle/Trunnion
Flex36 60-8	35.63 (905 mm)	Up to 9,000 (4,082 kg)	92 (2,337 mm)	8-9 (2,438-2,743 mm)	60 C.A. (1,524 mm)
Flex36 84-10	35.63 (905 mm)	16,000 (7,257 kg)	115 (2,921 mm)	10-12 (3,048-3,658 mm)	84-96 C.A. (2,134-2,438 mm)
Flex36 108-12	35.63 (905 mm)	16,000 (7,257 kg)	142 (3,607 mm)	12-14 (3,658-4,267 mm)	108-120 C.A. (2,743-3,048 mm)
Flex36 120-14	35.63 (905 mm)	16,000 (7,257 kg)	151 (3,835 mm)	13-15 (3,962-4,572 mm)	120-130 C.A. (3,048-3,302 mm)
108-12-20/36	35.63 (905 mm)	20,000 (9,072 kg)	126 (3,200 mm)	12-13.5 (3,658-4,115 mm)	102-108 C.A. (2,591-2,743 mm)
108-11-20	54 (1,372 mm)	20,000 (9,072 kg)	127 (3,226 mm)	11-13.5 (3,353-4,115 mm)	102-108 C.A. (2,591-2,743 mm)
120-16-20	54 (1,372 mm)	20,000 (9,072 kg)	146 (3,708 mm)	12.5-15 (3,810-4,572 mm)	114-130 C.A. (2,896-3,302 mm)
138-18-20	54 (1,372 mm)	20,000 (9,072 kg)	171 (4,343 mm)	14.5-17 (4,420-5,182 mm)	130-144 C.A. (3,302-3,658 mm)
168-20-20	61.75 (1,568 mm)	20,000 (9,072 kg)	195 (4,953 mm)	16.5-19 (5,029-5,791 mm)	168-180 C.A. (4,267-4,572 mm)
190-24-20	61.75 (1,568 mm)	20,000 (9,072 kg)	222 (5,639 mm)	18.5-21.5 (5,639-6,553 mm)	190-200 C.A. (4,826-5,080 mm)
96-10-24	54 (1,372 mm)	24,000 (10,886 kg)	115 (2,921 mm)	10-12.5 (3,048-3,810 mm)	84-102 C.A. (2,134-2,591 mm)
108-14-32	61.75 (1,568 mm)	32,000 (14,515 kg)	144 (3,658 mm)	12-15 (3,658-4,572 mm)	102-108 C.T. (2,590-2,743 mm)
138-18-32	61.75 (1,568 mm)	32,000 (14,515 kg)	176 (4,470 mm)	15-17.5 (4,572-5,334 mm)	130-144 C.T. (3,302-3,658 mm)
174-20-32	61.75 (1,568 mm)	32,000 (14,515 kg)	206 (5,232 mm)	17.5-20 (5,334-6,096 mm)	160-174 C.T. (4,064-4,420 mm)
190-24-32	61.75 (1,568 mm)	32,000 (14,515 kg)	223 (5,664 mm)	19-21.5 (5,791-6,553 mm)	174-190 C.T. (4,420-4,826 mm)
138-18-34	54 (1,372 mm)	34,000 (15,422 kg)	176 (4,470 mm)	15-17.5 (4,572-5,334 mm)	130-144 C.T. (3,302-3,658 mm)
108-14-40	61.75 (1,568 mm)	40,000 (18,144 kg)	144 (3,658 mm)	12-15 (3,658-4,572 mm)	102-108 C.T. (2,591-2,743 mm)
138-18-40	61.75 (1,568 mm)	40,000 (18,144 kg)	176 (4,470 mm)	15-17.5 (4,572-5,334 mm)	130-144 C.T. (3,302-3,658 mm)
174-20-40	61.75 (1,568 mm)	40,000 (18,144 kg)	206 (5,232 mm)	17.5-20 (5,334-6,096 mm)	160-174 C.T. (4,064-4,420 mm)
190-24-40	61.75 (1,568 mm)	40,000 (18,144 kg)	223 (5,664 mm)	19-21.5 (5,791-6,553 mm)	174-190 C.T. (4,420-4,826 mm)
138-18-52	61.75 (1,568 mm)	52,000 (23,587 kg)	176 (4,470 mm)	15-17.5 (4,572-5,334 mm)	138-144 C.T. (3,505-3,658 mm)
174-20-52	61.75 (1,568 mm)	52,000 (23,587 kg)	206 (5,232 mm)	17.5-20 (5,334-6,096 mm)	160-174 C.T. (4,064-4,420 mm)
190-24-52	61.75 (1,568 mm)	52,000 (23,587 kg)	223 (5,664 mm)	19-21.5 (5,791-6,553 mm)	174-190 C.T. (4,420-4,826 mm)
138-18-65	61.75 (1,568 mm)	65,000 (29,484 kg)	174 (4,420 mm)	15-17.5 (4,572-5,334 mm)	138-144 C.T. (3,505-3,658 mm)
174-20-65	61.75 (1,568 mm)	65,000 (29,484 kg)	206 (5,232 mm)	17-20 (5,182-6,096 mm)	160-174 C.T. (4,064-4,420 mm)
190-24-65	61.75 (1,568 mm)	65,000 (29,484 kg)	223 (5,664 mm)	19-21.5 (5,791-6,553 mm)	174-190 C.T. (4,420-4,826 mm)

■ Stellar® Slider (Sliding Jib)

Slider20 (Fixed)	54 (1,372 mm)	20,000 (9,071 kg)	143/185 (3,632/4,699 mm)	13-18 (3,962-5,486 mm)	138-156 C.A. (3,505-3,962 mm)
Slider20 (Fixed)	61.75 (1,568 mm)	20,000 (9,071 kg)	143/185 (3,632/4,699 mm)	13-18 (3,962-5,486 mm)	138-156 C.A. (3,505-3,962 mm)
Slider20 (Hyd.)	54 or 61.75	20,000 (9,071 kg)	143/185 (3,632/4,699 mm)	13-18 (3,962-5,486 mm)	138-156 C.A. (3,505-3,962 mm)
Slider26 (Fixed)	35.63 (905 mm)	Up to 26,000 (9,071 kg)	129/171 (3,277/4,343 mm)	12-16 (3,658-4,877 mm)	130-144 C.A. (3,302-3,658 mm)
Slider26 (Fixed)	54 (1,372 mm)	Up to 26,000 (9,071 kg)	129/171 (3,277/4,343 mm)	12-16 (3,658-4,877 mm)	130-138 C.T. (3,302-3,505 mm)
Slider26 (Fixed)	61.75 (1,568 mm)	Up to 26,000 (9,071 kg)	129/171 (3,277/4,343 mm)	12-16 (3,658-4,877 mm)	130-138 C.T. (3,302-3,505 mm)
Slider26 (Hyd.)	35.63 or 54	Up to 26,000 (9,071 kg)	129/171 (3,277/4,343 mm)	12-16 (3,658-4,877 mm)	130-138 C.T. (3,302-3,505 mm)
Slider26 (Hyd.)	54 or 61.75	Up to 26,000 (9,071 kg)	129/171 (3,277/4,343 mm)	12-16 (3,658-4,877 mm)	130-138 C.T. (3,302-3,505 mm)
Slider34 (Fixed)	54 (1,372 mm)	28,000 (12,001 kg)	168/208 (4,267/5,283 mm)	14-20 (4,267-6,096 mm)	160-174 C.T. (4,064-4,420 mm)
Slider34 (Fixed)	61.75 (1,568 mm)	34,000 (15,422 kg)	168/208 (4,267/5,283 mm)	14-20 (4,267-6,096 mm)	160-174 C.T. (4,064-4,420 mm)
Slider34 (Hyd.)	54 or 61.75	34,000 (15,422 kg)	168/208 (4,267/5,283 mm)	14-20 (4,267-6,096 mm)	160-174 C.T. (4,064-4,420 mm)
Slider40 (Fixed)	54 (1,372 mm)	37,000 (16,783 kg)	132/168 (3,353/4,267 mm)	12-16 (3,658-4,877 mm)	130-144 C.T. (3,302-3,658 mm)
Slider40 (Fixed)	61.75 (1,568 mm)	40,000 (18,144 kg)	132/168 (3,353/4,267 mm)	12-16 (3,658-4,877 mm)	130-144 C.T. (3,302-3,658 mm)
Slider40 (Hyd.)	54 or 61.75	40,000 (18,144 kg)	132/168 (3,353/4,267 mm)	12-16 (3,658-4,877 mm)	130-144 C.T. (3,302-3,658 mm)
Slider65 (Fixed)	54 (1,372 mm)	52,000 (23,587 kg)	193/224 (4,902/5,690 mm)	16-22 (4,877-6,706 mm)	180-190 C.T. (4,572-4,826mm)
Slider65 (Fixed)	61.75 (1,568 mm)	65,000 (29,484 kg)	193/224 (4,902/5,690 mm)	16-22 (4,877-6,706 mm)	180-190 C.T. (4,572-4,826mm)
Slider65 (Hyd.)	54 or 61.75	65,000 (29,484 kg)	193/224 (4,902/5,690 mm)	16-22 (4,877-6,706 mm)	180-190 C.T. (4,572-4,826mm)



For questions or to place an order, please contact HAWKEYE TRUCK EQUIPMENT at 515-289-1755 or 1-800-622-8223.

* This data is for reference purposes only, and is not intended to replace a properly calculated weight distribution.

Government specifications available.

* All specifications are subject to change without notification.